

DC pumps **ecocirc**[®] solar

The first DC spherical motor pump for direct connection to photovoltaic panels with automatic performance optimization using Maximum Power Point (MPP) tracking

- soft start at very low in-rush current (soft start algorithm, less than 1 Watt required)
- economical and powerful
- long life, blockage free and maintenance free
- RF suppressed
- protection against reverse polarity
- micro processor optimized flow



LAING

simply the best · by design

eco circ[®] solar

DC pumps

Application

The Ecocirc solar pump can be used for most circulation pump applications without connection to the power grid. Highly efficient, the Ecocirc solar can be connected directly to a photovoltaic panel and is characterized by its small size, high efficiency, extreme low power consumption and its Maximum Power Point (MPP) tracking. The shaftless spherical motor technology provides maintenance free and quiet service life. This pump is perfect for single family home thermal solar systems or any circulation pump application where conventional power is not available.

Design

The principle of the spherical motor, which was invented by Laing, is fundamentally different from conventional canned motor pumps. The only moving part in a spherical motor is a hemispherical rotor/impeller unit which sits on an ultra-hard, wear-resistant ceramic ball. There are no conventional shaft bearings or seals. This eliminates bearing noise and seal leaks. This pump is robust and has an estimated service life in excess of 50,000 hours. The self-realigning bearing is lubricated and cooled by the media. Maintenance is not necessary under normal conditions. Even after prolonged shutdown, the pump will start reliably. All parts exposed to the fluid are completely corrosion resistant.

Soft start-up

The Ecocirc Solar pump has a soft start-up feature which reduces high in-rush current. When the photovoltaic panel provides sufficient power, the pump goes through the alignment phase by turning the rotor into the position required for start-up. The processor then waits until the capacitor is sufficiently charged. This enables a start-up with minimal power (less than one watt). Cycling due to unsuccessful attempts is minimized. Even after prolonged shutdown, the pump will start reliably.

Over-temperature safety device

The Ecocirc Solar pump comes with an integrated over-temperature safety device which shuts off the pump electronics when reaching temperature over 230°F. When the temperature of the pumped fluid is below 203°F the pump will function normally. The temperature of the electronic components is influenced by the temperature of the pumped media as well as by the speed setting. After reaching a critical temperature 203°F the pump will lower its speed automatically in order to avoid a total shutdown. However, if the temperature continues to rise (e.g. caused by too hot pumped media), the pump will eventually shut down completely. After cooling down, the pump will restart automatically.

Automatic performance optimization - Maximum Power Point (MPP) tracking

The Ecocirc Solar pumps are the first and only spherical motor pumps with self-optimizing performance to maximize use of available power of a solar PV panel. Every three seconds the processor will modify its operating point on the voltage-current curve of the PV panel to find the point of maximum performance. This is called the "Maximum Power Point" (MPP). At this point, the pump achieves the maximum rpm and therefore the maximum performance. There is no need for a separate performance device required. The Ecocirc Solar pump will always find its best operating point under any given light and temperature conditions.

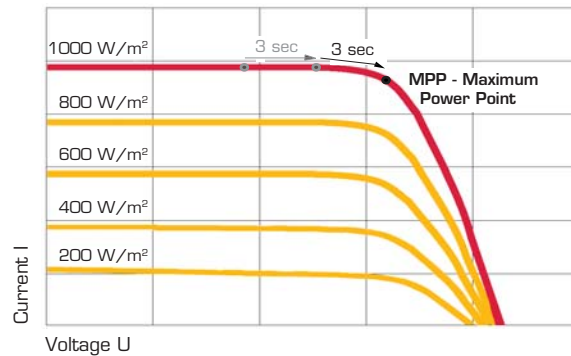

Typical Current-Voltage-curve of a photovoltaic panel. By employing MPP tracking every three seconds, the Ecocirc DC pumps always automatically achieve maximum performance at any given insolation.

Technical Data

Motor design	Electronically commutated spherical motor with permanent magnet rotor/impeller	
Voltage	12 - 24 Volt	
Power consumption*	min. start-up power consumption less than 1 Watt, max. power consumption 22 Watts	
Current draw	0.25 - 1.46 A	
Acceptable media	domestic hot water, heating water, water/glycol mixtures, other media on request**.	
Environment	IP 42	
Insulation class	Class F	
Pump housing material	Brass	Noryl
Max. system pressure	150 PSI	50 PSI
Max. system temperature***	14 to 230° F	32 to + 140° F
Weight	1.54 lbs	0.77 lbs

* Power consumption and start may vary in different installations

** please check pump performance with more than 20 % glycol

*** non-freezing

Design

DC pumps Ecocirc solar

Stator with integrated MPP technology, over-temperature safety device and soft start-up

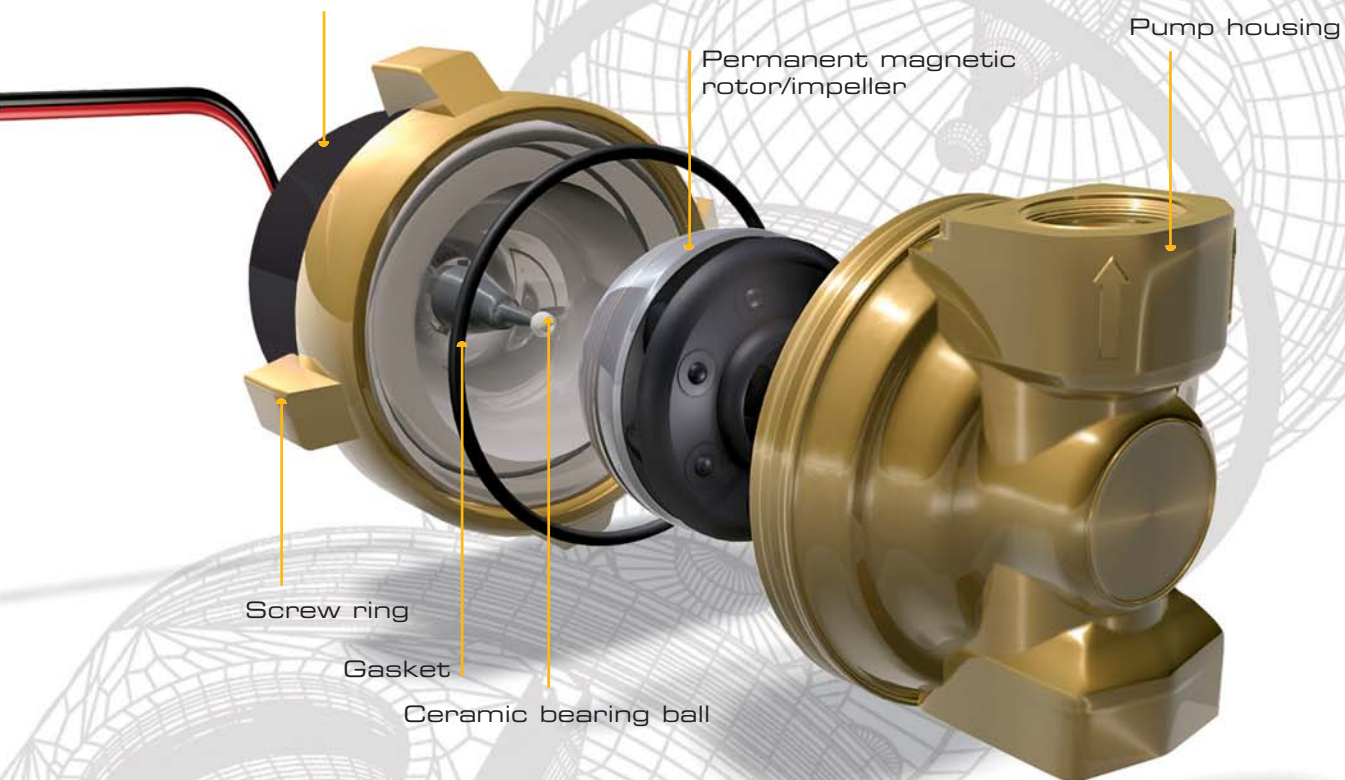

ecocirc® solar DC pumps

Model	Pump housing material	Max. system temperature	Housing design	Connection	Max. pressure
D5 solar 720 B	Brass	230° F	Inline	1/2" female thread	150 PSI
D5 solar 090 B			Inline / BV+CV+PV*	1/2" union sweat	
D5 solar 850 N	Noryl	140° F	Angled housing	1/2" male thread	50 PSI
D5 solar 810 N			Angled housing	1/2" hosebarb thread	
D5 solar 790 N			Angled housing	3/4" hosebarb thread	

* built-in ball check valve and purge valve

Dimensional drawings for Ecocirc® solar DC pumps

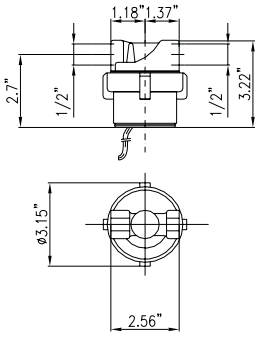

D5 solar 720 B

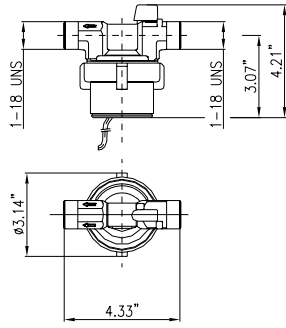

D5 solar 090 B

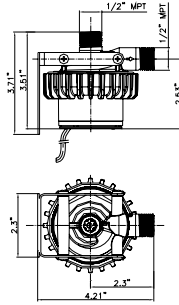

D5 solar 850 N

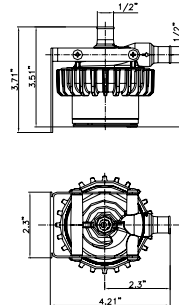

D5 solar 810 N

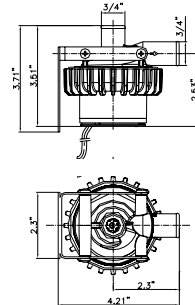

D5 solar 790 N

Pump curves

At 12 Volt, min. start-up power consumption less than 1 Watt (12 Volt panel), max. power consumption approx. 22 Watts;



D5 solar 720 B

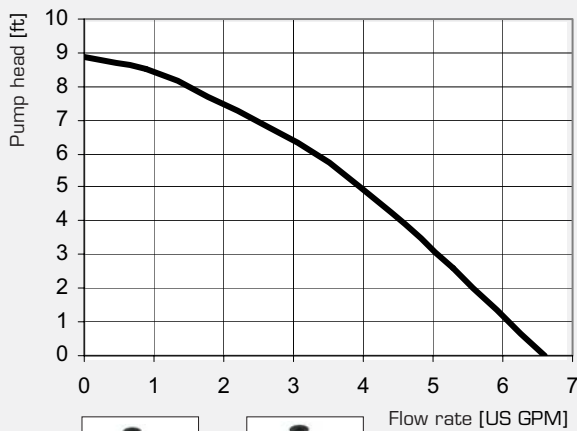

D5 solar 090 B



D5 solar 850 N



D5 solar 790 N



D5 solar 810 N

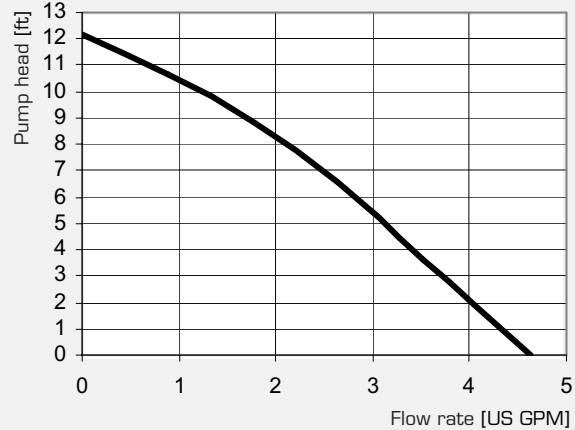

29092006 Subject to change without notice

